

M I S S O U R I

# ELECTRIC FENCING *for* SERIOUS GRAZIERS

UNITED STATES DEPARTMENT OF AGRICULTURE



 NRCS Natural Resources Conservation Service

# ELECTRIC FENCING

*for*  
SERIOUS GRAZIERS

## C O N T E N T S

---

Selecting an Energizer	7
Grounding Recommendations	7
Energizer Installation	8
Alternative Grounding System	9
Testing your Grounding System	9
Energizers & Lightning	10
Selecting Wire	12
Temporary Fencing	13
Installing Electric Fence	16
Tools	16
Safety	28
Floodplain Fences	29
Electrical Terms	31
Troubleshooting	33



# Electric Fencing for Serious Graziers

## tip:

*For more information about getting started with electric fencing or how to improve your existing system, contact the NRCS office serving your county. Look in the telephone directory under "U.S. Government, Department of Agriculture," or access this website: <http://offices.usda.gov>.*

The information in this publication is based upon the experiences of NRCS personnel and graziers during the past 20 years. This is not intended as a detailed how-to manual about fence building. Those are available from numerous sources. Graziers should collect manuals from several fence companies to learn the techniques that could apply to their operations.

Techniques described here are primarily for producers installing one-wire and two-wire fences and permanent power stations using 110-volt energizers.

Approach electric fence construction with the same frame of mind and skills as you would with any other electrical wiring. Getting shocked by a modern energizer when you get careless won't kill you. But for a while, you might wonder!

Graziers should make every attempt to purchase the best quality products available, which doesn't necessarily mean the most expensive. For instance, there is little difference in the price for junk insulators and the price for quality insulators. People who purchase lower-quality insulators will probably regret it, especially when the substandard insulators start arcing and causing voltage problems. Purchase quality fence components that will last for the life of the fence.



# Reasons to Consider Electric Fencing

Electric fencing, sometimes called power fencing, is an effective way to control livestock on most farms. The only places where electric fences should not be used are in cattle-handling facilities where quick exits might be necessary or near the milking facilities of dairy operations.

## Advantages

Electric fencing offers two major advantages over other types of fencing. One is cost. The cost to install a four-strand, barbed-wire fence is about \$5,000 per mile. The cost to install a typical, single-wire, electric fence is about \$1,600 per mile. If necessary, additional wires can be added to an electric-fence for about 10 cents per foot. There could be additional costs to install electric fencing in certain cases. For instance, Missouri law requires that property line fences be at least four feet tall and have posts at least every 12 feet.

The other big advantage of electric fencing is its ease of construction, which improves forage management opportunities. Small pastures can greatly enhance harvest efficiency and increase the amount of forage produced from a grazing system because of the amount of rest that is introduced into the system.

### tip:

*Electric fencing is a cost effective and easy way to manage your grazing system.*

# Selecting an Energizer

The energizer is the heart of any electric-fence system, so select it carefully. A good unit will provide years of service if it is properly installed and maintained. Price should not be the determining factor. Many operators have started with farm-store specials that ended up crashing. The cost to purchase two or three cheap models is as much or more than the cost of purchasing a good one initially.

Purchase a low-impedance energizer with a minimum 5,000-volt output. It should produce 35-65 pulses per minute with each pulse lasting not more than 0.0003 seconds. Each pulse also should have an intensity of less than 300 mAmps.

Seek advice about energizers from experienced graziers, from sales people and from NRCS personnel. NRCS employees cannot recommend specific brands, but they can offer general advice. One



of the best methods is to look at several operations similar to yours, and find out what those graziers are using and if they are happy with their units.

Consider the type of livestock to be controlled. For example, containing sheep, goats or horses may require special considerations for charger size and fence construction to ensure that the animals receive adequate shocks when they contact electric fences.

Purchase a larger unit (energizer) than you think you need because graziers usually expand their systems as they realize the benefits of modern electric fencing. Also increase the size of the energizer if you anticipate a high weed load near the fence.

All energizers should come with manuals that explain installation and operation. Study the manual carefully. Also refer to **Drawing 1**, page 8, for installation instructions.

# Grounding Recommendations

1. Use galvanized ground rods when using galvanized wire and clamps for the grounding system. With stainless steel connectors on the energizer, copper can be used all the way. Use the same type of metal throughout; do not mix dissimilar metals.
2. Use good clamps and ground rods with a diameter of at least one-half inch. A rule of thumb is to drive at least three feet of rod into the ground per joule of output. Keep fencing ground rods at least 65 feet from the ground rods of any existing utilities. Place rods 10 feet apart to increase the probability of having contact with moist soil.
3. Some installers recommend driving ground rods at 45-degree angles in rocky soils. This enables the rods to glance off rocks and continue downward. Since the angle decreases depth, more rods may be necessary.
4. To eliminate the possibility of stray voltage at dairy operations, keep the energizers and grounding systems as far as possible from the milk barns.
5. Be aware of underground utilities and fuel-storage tanks. Avoid these by the greatest distance practical.

# Drawing 1 Energizer Installation

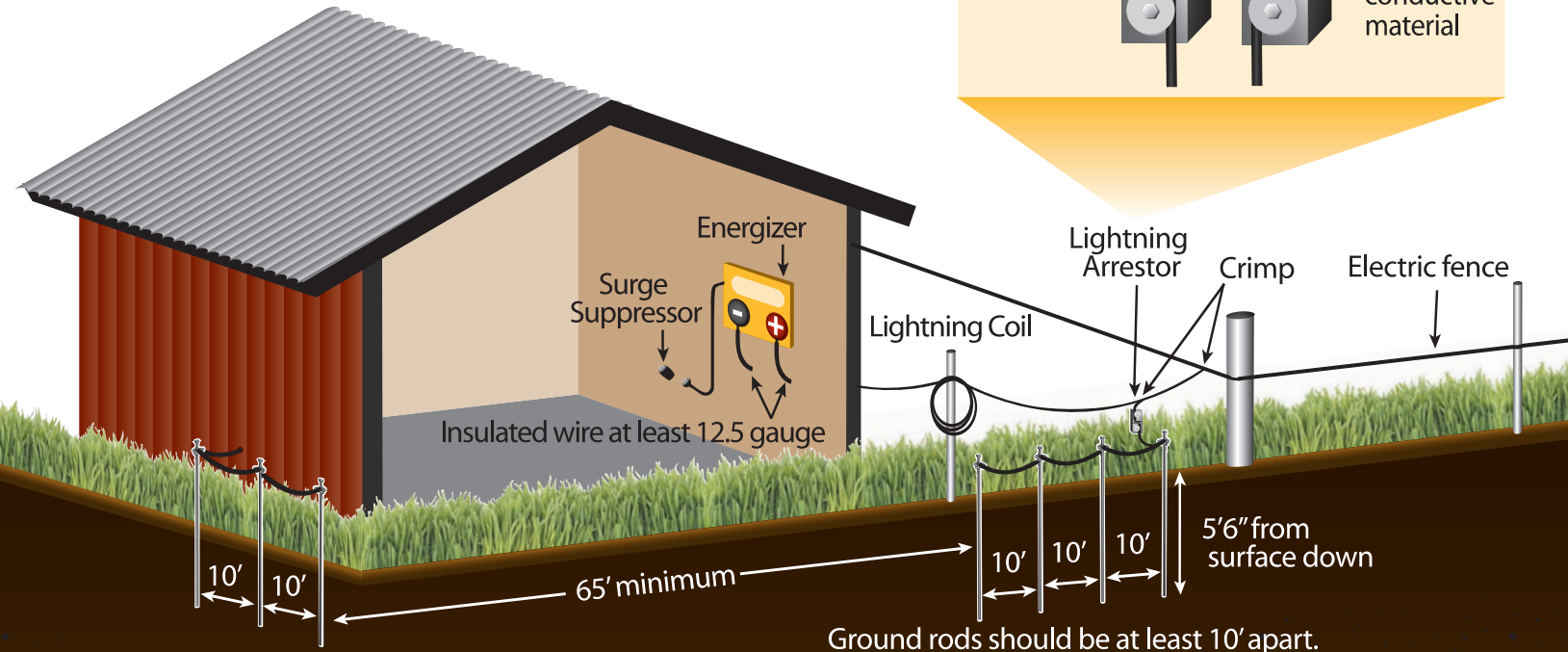
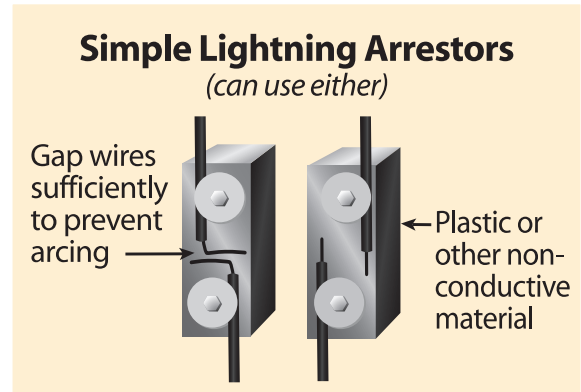

Use at least 3 energizer grounding rods, placed at least 10' apart and in dripline of roof or fenceline.

Ground rods should be at least 10' apart. At least one more rod than Energizer grounding rods.

## Notes:

1. Protect energizer unit from exposure to the weather.
2. Ground rods should be 1/2 inch in diameter or larger and galvanized. Use proper galvanized clamps on rods.
3. As a minimum, install total number of ground rods as recommended by manufacturer of energizer.
4. Place energizer ground rods at least 65 feet from any existing metal structures or waterlines and from any utility company ground points (including building grounds).
5. Drive all ground rods at least 10 feet apart, and connect with a continuous wire of a minimum 12.5 gauge.
6. Keep tops of ground rods, clamps, and connecting wire above the soil surface. Do NOT bury.
7. Lightning protection grounding should be at least 65 feet from any other grounding system: This should have at least one more grounding rod than the energizer system.

# Alternative Grounding Systems

Here are a few alternatives to using metal rods or pipe in energizer grounding systems.

1. Burying a large metal object is a desirable option. A two-foot-by-eight-foot sheet of roofing metal, for instance, has a surface area of 4,600 square inches, while a one-half-inch diameter, eight-foot-long ground rod is only 151 square inches. The metal sheet is equal to 30 ground rods.
2. Clean rust and grease from any metal used, and weld a ground rod to the sheet. The rod

## tip:

Refer to the trouble shooting section on page 33, for more detailed information on testing your grounding system.

promotes a good electrical connection by providing a way to attach a clamp to the sheet.

The clamp is necessary to securely connect the wire from the energizer. The metal sheet still needs to be buried deeply. (In the shallow, rocky soils of Missouri's Ozarks region, creating an adequate hole probably will require more than a pick and shovel.)

3. Dig or drill three-inch diameter or larger holes at least 35 feet apart and at least four feet deep. Fill the holes with a wet mix of two parts bentonite to one part coarse rock salt. Insert a half-inch or larger stainless-steel rod in each hole. Add water to the holes during dry weather.
4. Plowing in lengths of wire as deep as possible and connecting them to a common point may be an alternative in some soil conditions.

# Testing Your Grounding System



Use a **digital volt meter** to determine the adequacy of a grounding system. Here's how to properly test a ground field:

- 300 feet from the charger, ground out the fence to 2,000 volts or less. You might need to lay three to six steel posts on the fence to reduce the volts to this level.
- With the digital volt meter, check the voltage on the last ground rod in the system (not the posts used to ground out the fence for this test). The reading on the last ground rod should be zero, but most chargers can tolerate up to 300 volts. If the voltage is more than 300, add additional ground rods until the voltage is in the tolerable range. Make every effort possible to attain a zero reading.

## Grounding Errors

Most electric-fence problems are caused by poor grounding, which can result from several errors.

### 1. Not enough ground rods

A grounding system depends upon the surface area of metal ground rods contacting moist soil to complete a circuit. The grounding system does not function if too few rods are used or if the soil is dry.

### 2. Dry soil

Anticipate a long, dry summer – the worst possible conditions – when selecting the grounding system location. A good location is on the north side of a building, under the drip line, with the rod driven at an angle back under the floor. Also consider wet areas, such as lagoons or ponds. The grounding system does not have to be located right next to the energizer. Move several hundred feet away, if necessary, to find the best location.

### 3. Ground rods are not deep enough

It's not unusual for landowners to drive ground rods when the soil moisture is low, only get the rods a few feet deep, and then get discouraged and cut the rods off. If the ground is so dry that rods can't be driven, it's probably dry enough that the grounding system won't function anyway. Either finish driving the rods into the ground after the subsoil/fragipan gets moisture or move to a more desirable location. Do not cut the ground rods off.

# Protecting Energizers from Lightning

With all energizer installations, install adequate lightning protection before constructing the fence.

1. Use a good surge protector on the utility power side of the energizer to protect it against power fluctuations. Most energizers are damaged from the power side, not the fence side.
2. Install a lightning choke in the lead-out cable. You can purchase these or build them (**Drawings 2 and 3**).
3. Install a lightning arrestor in the lead-out cable that is connected to the powered fence. Then connect the arrestor to the lightning grounding system.
4. Install the lightning protection grounding system at least 65 feet from the energizer grounding system. The lightning protection grounding system needs to be a more efficient system than the grounding system for the energizer. Therefore, use at least one more ground rod in the lightning protection grounding system than is used in the energizer grounding system. Select sites for lightning protection grounding systems with care so that a lightning strike does not go to ground in the middle of a herd of cattle or where people are congregated.
5. It also helps to install ground rods and arrestors at permanent wet spots along lengthy fences because wet soil provides an excellent ground.
6. With multi-wire fences, be sure to connect all of the wires to the lightning arrestors. The top wire is the first line of defense against lightning damage.

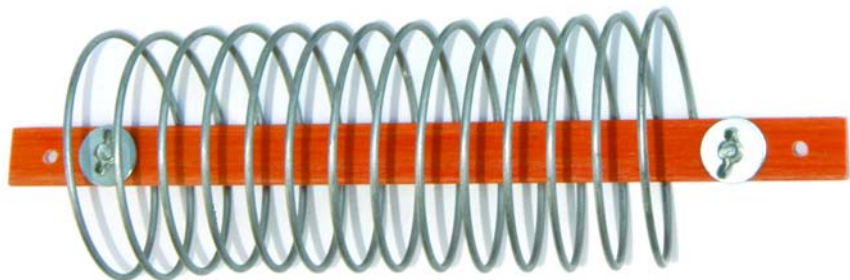

*Manufactured lightning choke*



## Drawing 2 Lightning Choke

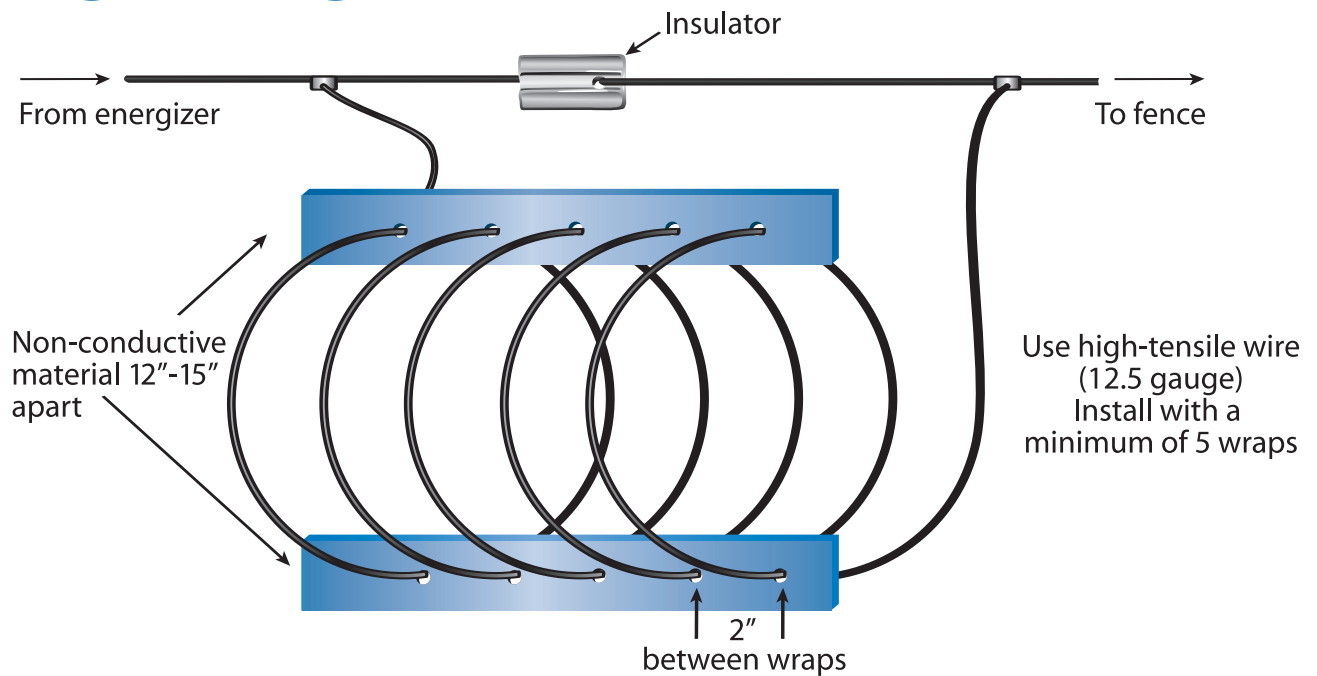

## Drawing 3 Lightning Coil

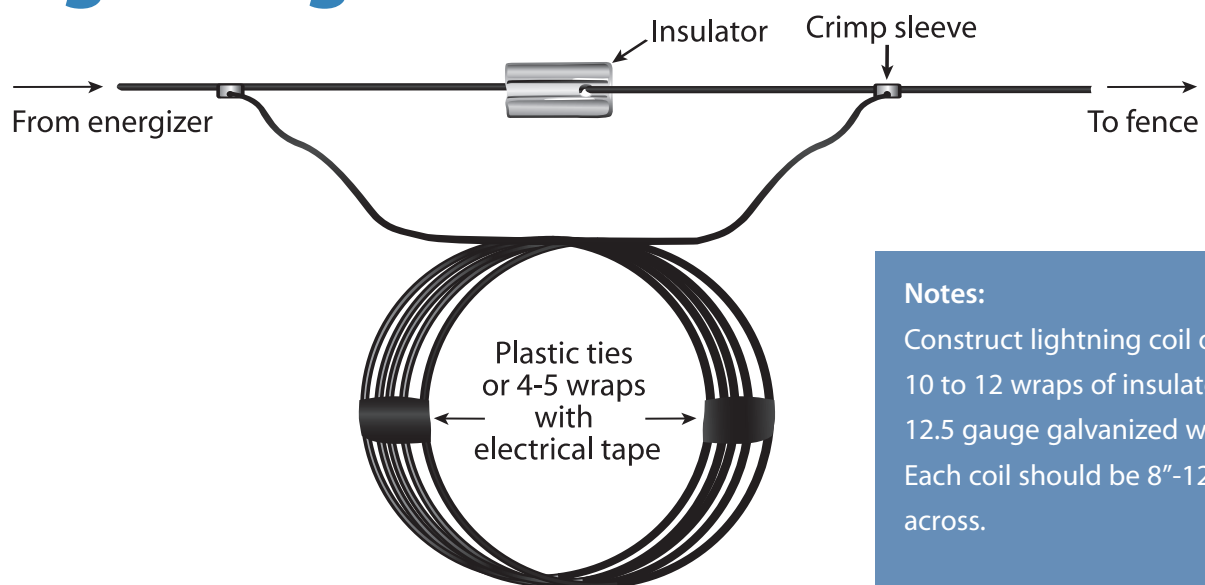

### Notes:

Construct lightning coil of 10 to 12 wraps of insulated 12.5 gauge galvanized wire. Each coil should be 8"-12" across.



# Selecting Wire

Use at least 12.5 gauge, high-tensile wire with type III galvanizing for permanent and semi-permanent fences. Avoid wire rated at 200,000 p.s.i or more, however, because it's very stiff and hard to handle. Wire that is smaller than 12.5 gauge has a high resistance to current movement, and on a longer run might necessitate the use of a larger, more expensive energizer. The following chart illustrates this point:

Gauge	OHMS/Mile
8	22.5
10	35.4
12.5	56.4
14	87.0
16	136.9

In other words, 16-gauge wire is 2.5 times as resistant to current movement as 12.5-gauge wire. Aluminum is four to six times as efficient as steel wire, but solid aluminum wire is soft and easily broken.

Aluminum-coated steel wire is available, and is a viable alternative. Aluminum is only 60 percent as efficient as copper, but the price of copper or copper-coated wire would be prohibitive.

Never electrify barbed wire because – in addition to being more costly – the barbs on the wire greatly increase the resistance of the wire, the wire is not galvanized adequately to prevent rust, and it is more likely for a person or animal to become entangled in it. Safety is of the utmost importance.

*Plastic-coated horse wire (left) and 12.5 gauge high-tensile, galvanized wire are examples of permanent fencing wire.*

*Plastic-coated horse wire is more visible and less likely to cut a horse that may run into it.*

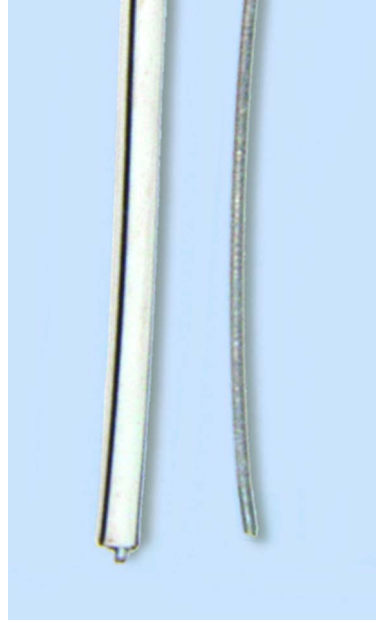

## Temporary Fencing



*Examples of temporary fencing wire*

Polywire is a very useful product that most landowners can utilize for paddock divisions, strip grazing, etc. But the fine, metal conductors in polywire and polytape products create a very high resistance to current flow. Therefore, don't depend on it for long runs.

Use six-strand and nine-strand polywire with stainless steel conductors for temporary fencing. Six-strand polywire has a resistance of 9,700 ohms per mile, and three-strand polywire has a resistance of 16,000 ohms per mile.

### tip:

*A one-sixteenth-inch cable makes an excellent temporary fence. It is cheaper and more durable than polywire. The cable is also more effective than polywire at controlling deer traffic.*



*Example of a temporary fence post and wire*

Graziers need temporary fencing to fine tune all grazing systems so that they get the most benefit from their forage. This is especially true in the spring, when forage plants are growing the fastest, and in the winter, when graziers are trying to stretch their forage the farthest. Here are some temporary-fencing tips to make the job quick and easy:



*Temporary fence posts*

1. **Use polywire that has at least six strands.**
2. **If you will be moving fences frequently, use treadin posts.** Select posts that have small-diameter spikes and wide tread plates because they will be easier to get in the ground. Polywire is light, so large, sturdy posts are not necessary. A post every 40-60 feet will usually maintain the desired wire height.
3. **When grazing stockpiled forage, start on the end closest to water.** Don't worry about constructing a back fence to protect areas that have already been grazed because the grass won't grow again until the next spring.
4. **Steel posts without braces are more than adequate for corners and gates.** Polywire is not strong enough to pull over a "T" post.
5. **Use the same end insulators and gate handles that you would use for high-tensile fencing.** Treadin posts and fiberglass posts will not require additional insulators, but the appropriate clips are necessary for attaching polywire to fiberglass posts.



# Wire Splices and Joins

When making permanent connections in electrical fences, make sure that the joins make good electrical connections. One loose connection can equal a resistance of 500 ohms, and a few loose connections can cause a significant voltage drop.

Use good-quality crimp sleeves, crimped with the proper crimping tool, to make electrical connections. A round, hard material such as high-tensile wire does not make a good electrical connection when wrapped back around itself. Therefore, avoid knots and wraps unless the person constructing the system has the ability to make tight wraps.

Too many graziers depend upon their energizers being able to punch their way through loose wraps instead of taking a little more time to do it right. Wrapping wire properly requires practice. Keep in mind that a person's wrist gets fatigued after performing several hand wraps, which causes subsequent wraps to get increasingly looser.

Knots in high-tensile wire reduce the wire's effective strength by about 30 percent.

Make joins in polywire by twisting the metal conductors together separately rather than simply tying a knot with the plastic strands included.



**tip:** Use at least three wires for sheep or goats.

# Installing Electric Fences

People installing electric fences often make the mistake of pulling the wire too tight. Pulling the wire tight requires big corner posts and braces that are overkill for one-wire and two-wire fences. Only tighten wires enough to take most of the sag out of them.

Along woodlands where trees or branches might fall on fences, it is a good idea to include tension springs to add some “give” to the fences. Consider using tension springs where deer traffic is heavy. Springs could prevent some damages to fences and also save the inconvenience of having livestock escape before the damaged fences are discovered and repaired. Also, by driving posts on alternate sides of the wire, only one insulator will likely be damaged if a deer runs into the wire.

Spacing for posts and stays may vary from 40 to 150 feet, depending on the terrain. The posts need to be closer on steep or uneven terrain. With spacing at 150 feet, install stays to maintain the proper wire height. The stays can be small fiberglass posts, three-eighths-inch diameter or larger, placed about 50 feet apart.

The wire height should be about two-thirds the height of the animal. In most situations, one wire will be adequate for cattle. However, two or three wires might be needed along lanes and crop fields. You also might need multiple wires to accommodate certain management practices, such as weaning across the fence. Use at least three wires for goats and sheep.

With multi-wire fences, consider using a current limiter or a flood-control switch on the lower wires if you anticipate a heavy weed load.

Electric fences do not need to be straight; they are flexible enough to be installed on soil boundaries or woodland edges.



## tip:

*Installing switches in fencing systems can save time because they can be used to isolate areas. They also allow a grazier to shut off one section of a fence to make repairs, instead of having to go back to the energizer and shutting down the whole system.*

## Necessary Tools

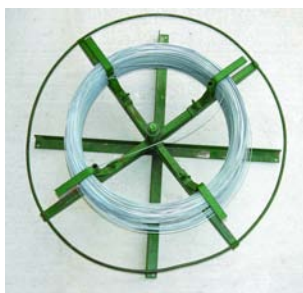

*Spinner*

Something that resembles a 2,000-foot or 4,000-foot Slinky®. These spinners can be home-built, **Drawing 4**, or commercial, but they should be constructed with spring brakes to prevent wire from over running.

A **spinner or reel** for high-tensile wire is definitely necessary. 12.5-gauge, high-tensile wire is packaged in tight coils, and cutting the last tie without having the coil on a spinner will result in



*Crimper*

You will need a **crimper** to make good electrical connections. The crimper should make a round crimp. Crimpers for splicing barbed wire make flat crimps that are not adequate on round, high-tensile wire (**Drawing 5**).

## Drawing 4 Home-Built Spinner

### SIDE VIEW

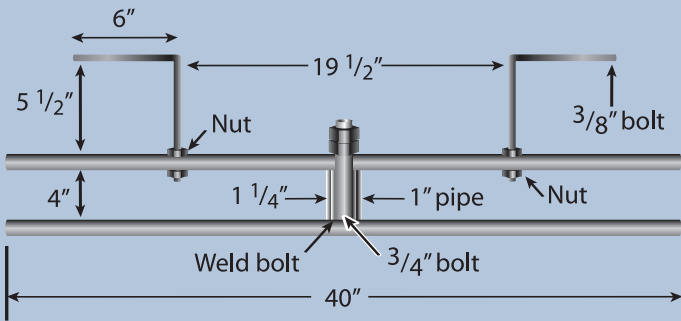

### Home-Built Spinner Notes:

1. May be built out of typical scrap pile.
2. Use square tubing, angle iron.
3. No measurement is critical – needs to fit a roll of high-tensile wire and pivot freely.
4. Use bolt and pipe, old hub, etc., for pivot.
5. Base can be plywood, metal, or old tire with concrete. Bolted down or free standing can also be constructed to be operated vertically

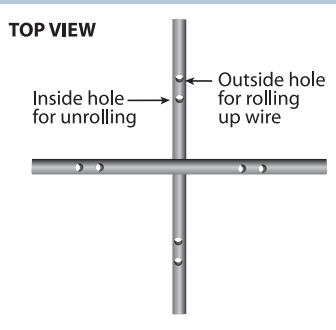

## Drawing 5 Home-Built Crimper Using Bolt Cutter

### SIDE VIEW - Jaws

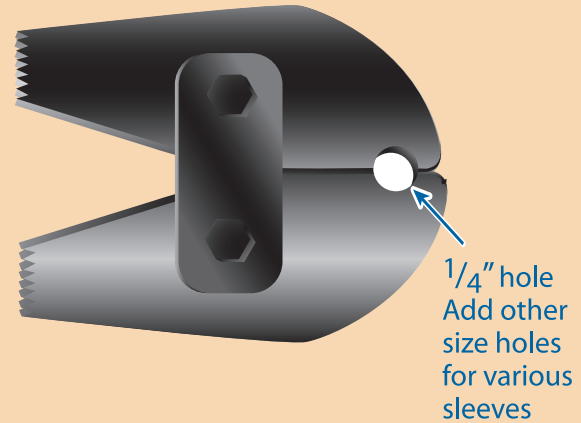

### FRONT VIEW - Jaws

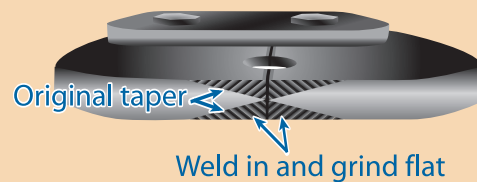

A **digital volt meter** makes it easier to test grounding systems and to troubleshoot problems. Testers that have fault finders can greatly aid in locating subtle shorts.

Reels save time and increase the life of polywire. Purchase fence reels or use electrical extension-cord reels. Some fence reels hook on steel posts or over hot wire. Some reels have gears that make it much easier to roll up wire. Shop around and find the reel that will best fit your particular need.



## Components Insulators

**Insulators** may be made of glass, porcelain, or plastic.

Very few glass insulators are produced, and white porcelain insulators are cheap and do not stand up to the sun or today's high-powered chargers. Exposure to the sun's ultraviolet rays causes minute cracks to develop in porcelain insulators. The cracks then collect moisture that causes arcing.

Plastic insulators are most often used. Some plastic insulators are junk, while others are very good quality. Use only insulators made from high-density polypropylene or polyethylene. Black insulators appear to last the longest.

Before purchasing insulators, check the war-

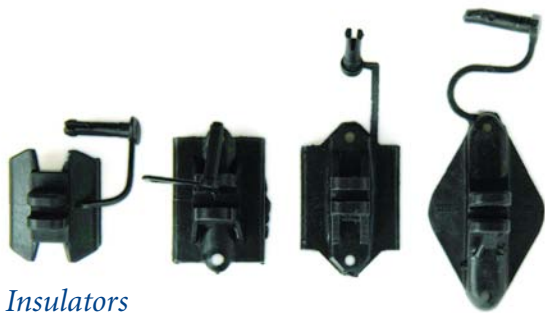

*Insulators*

ranties. Only insulators with at least 10-year warranties are of sufficient quality. Many different configurations are available (end insulators, snap on, nail on, etc.). Steel “T” posts vary in size, so test snap-on insulators to make sure that they fit the posts in your fencing system before you purchase a large quantity of them.

Avoid the temptation to save money by using garden hose or discarded hydraulic hose as insulators. Some of these hoses conduct electricity, and most of them will break down from exposure to sunlight.

### Insulated Wire (Underground Cable)

**Insulated wire** is normally used where wire is buried under gates and as leads from the energizer to the fence. It also can be used to construct a lightning coil. When purchasing insulated wire, look for double-insulated, 12.5-gauge wire. Some suppliers sell 16-gauge wire, which is not recommended because it restricts the flow of current.

Insulated wire is available as high-tensile or soft steel. In most situations where insulated wire is used there is no tension on the wire, so the soft-steel wire is quite adequate. It’s also easier to handle.

Aluminum insulated wire is also available, but it is prone to break where the insulation is cut. It’s



*Double- insulated underground cable*

not compatible with galvanized high-tensile wire because the dissimilar metals cause electrolysis.

Never use insulated wire intended for normal 110-volt or 220-volt installation because it will be either copper or aluminum. Connecting the copper or aluminum to the galvanized wire will cause electrolysis. In addition, the insulation on these types of wires is not designed for the high voltage of a fencing system.

Insulated wire should run through a non-metal conduit where it is underground to prevent the wire from getting punctured by rocks (**Drawing 7**). Using three-quarter-inch gray electrical conduit and sweep elbows provides a good, water-tight passage for underground cable.

### Lightning Arrestors

**Lightning arrestors** have air gaps wide enough to keep fence voltage from jumping but narrow enough for lightning strikes to pass.

Purchasing adjustable arrestors (see below) or making your own – using **Drawing 6** as a guide – are preferable choices.

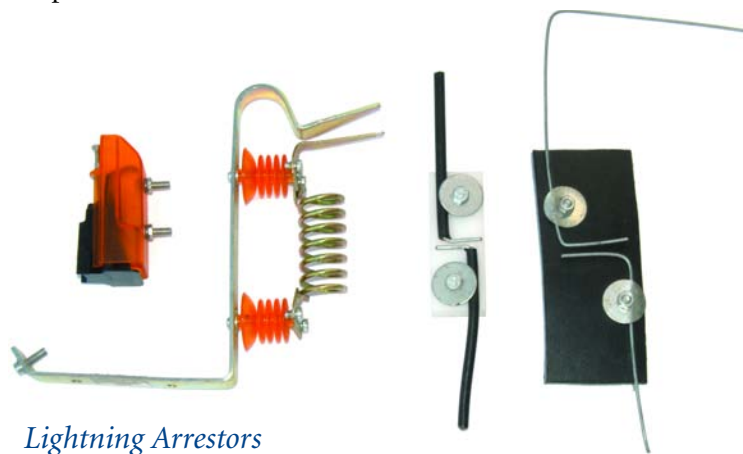

*Lightning Arrestors*

### Surge Protectors

Install surge protectors at the same time as energizers. Many quality surge protectors are available. Some of the more expensive protectors even warranty the items they are protecting.



## Drawing 6 Home-Built Lightning Arrestors

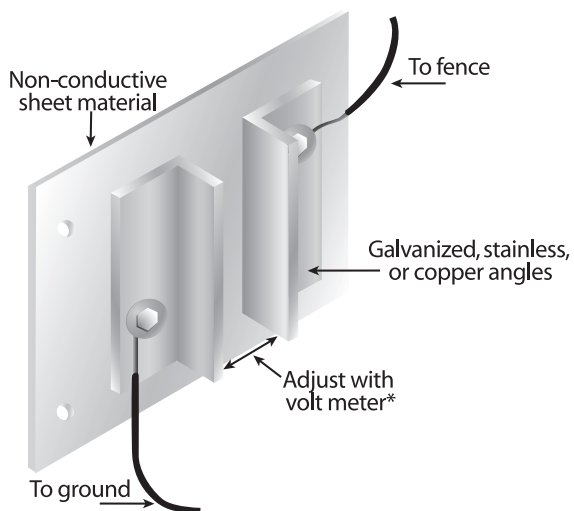
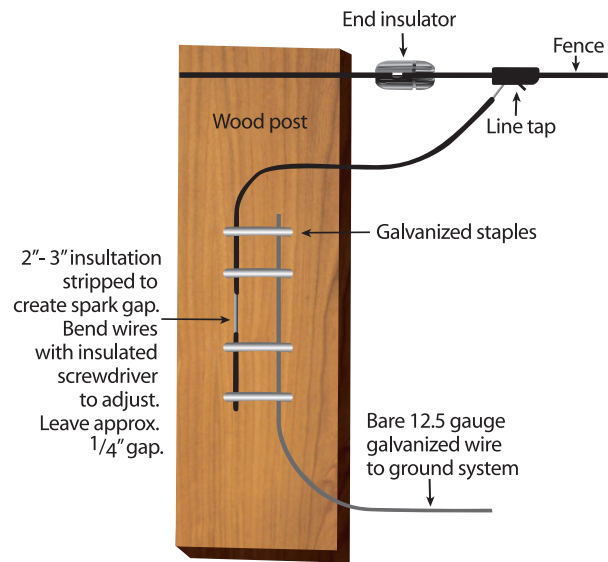
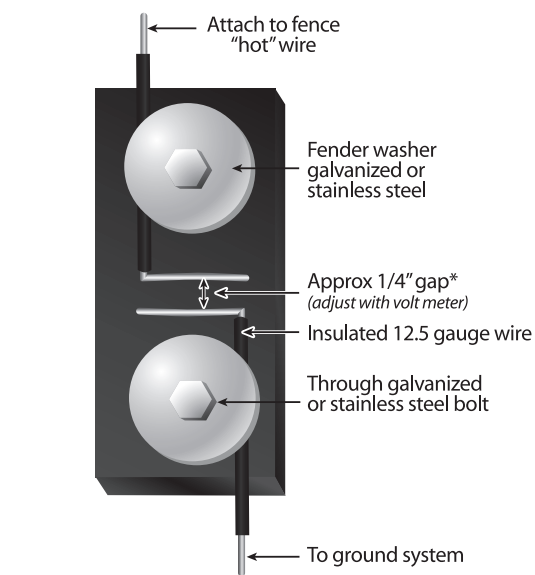

### \*Adjusting Gap with a Volt Meter

1. Set energizer to highest setting.
2. Secure lead from fence.
3. Leave lead to ground loose enough to slide.
4. Leaving lead to ground unattached at grounding end, clip volt meter to ground system then to end of lead.
5. Slide lead at arrestor apart until voltage is no longer read on volt meter.
6. Tighten lead on arrestor and then secure to grounding system (after removing volt meter).

Another method is to slide leads apart until arcing no longer occurs, then check with volt meter.

## Ground Rods

Most grounding systems for modern electric fences use rods. But clean, galvanized-steel pipe can be substituted. Rods as small as one-half inch in diameter can be used, but larger sizes may be easier to drive into the ground.

Use galvanized rods if high-tensile, 12.5-gauge wire is attached to the charger. In that case, clamps should also be galvanized. Copper wire, clamps and rods may be used if the energizer terminals are stainless steel. But do not mix dissimilar metals.



## Drawing 7 Electric Gate (not hot when unhooked)

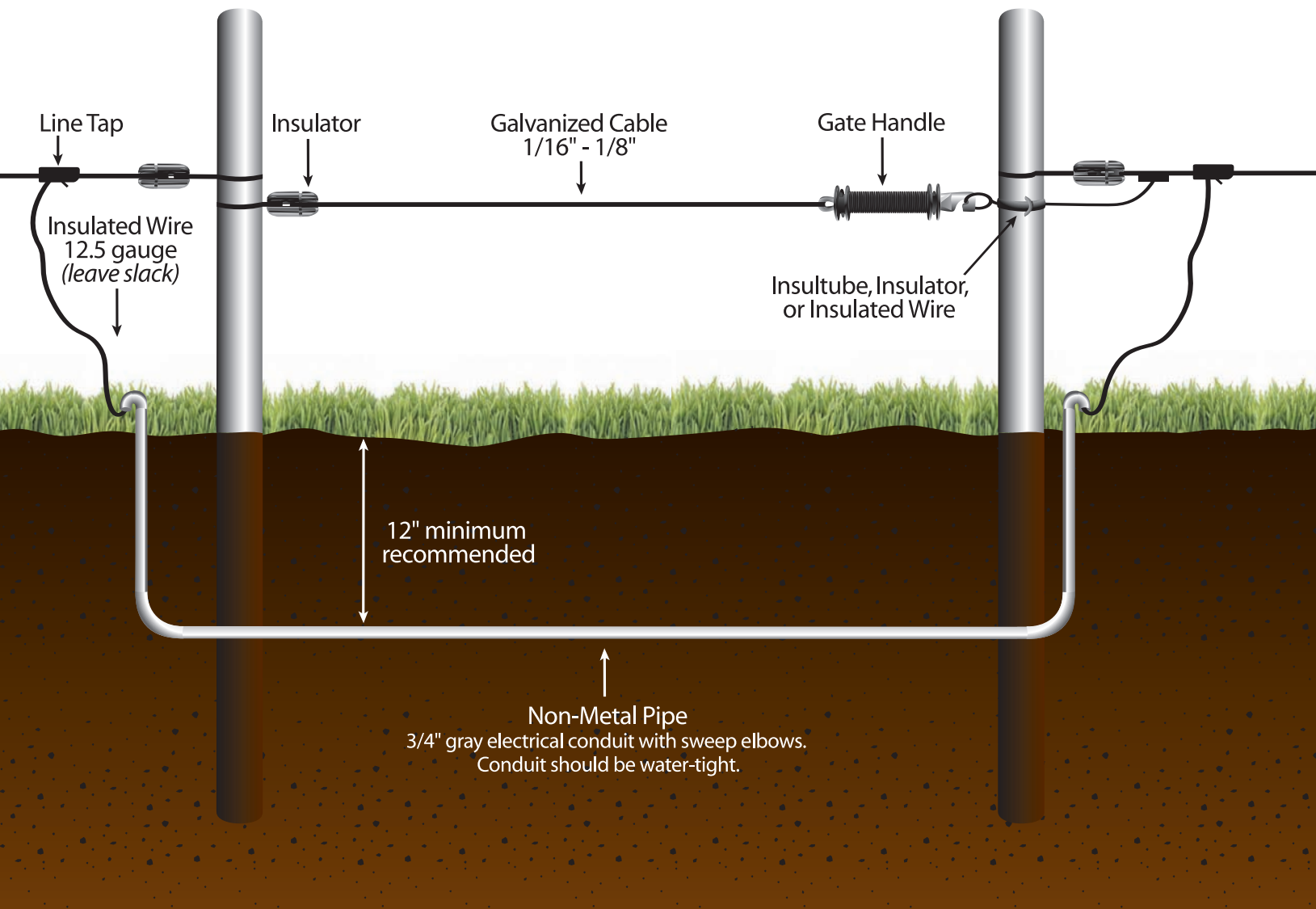

### Crimp Sleeves



Sleeves and taps should be good quality, galvanized or stainless steel. Avoid the cheaper "gold-plated" sleeves because they rust quickly. The rust ruins the coating on the wire and causes the system to fail. To ensure a good electrical connection, be sure to purchase crimp sleeves that fit 12.5-gauge wire.

### Line Taps



Line taps can be either the crimp type, which make a permanent connection, or the type that connect with a split bolt. Split-bolt line taps (pictured below) are recommended for gates and other areas that may need to be changed out occasionally. Galvanized components seem to be more resistant to rust than hot-dipped components.



## Current Limiters

Current limiters are used for situations where high water, excess weed load, etc., could cause shorts. Current limiters shut down those portions of fences when shorts occur.

## Posts

Many different types, configurations and brands of posts may be used with modern electric fences.

1. **Steel T posts** are used somewhere in most systems, and they work well if quality insulators are used.

2. **Fiberglass T posts** are fairly expensive, and they don't appear to last long.

3. **Wooden posts** of many different sizes and shapes can be used with quality insulators.

4. **Round fiberglass posts** with diameters of at least five-eighths inch are very satisfactory. The less expensive posts have an exterior coating that deteriorates after about a year. The deterioration makes it necessary to wear leather gloves when working with the posts, but the posts will still function fine. Clips for attaching wire to the posts are available for most sizes of posts.

## Drawing 8a Floating Angle Brace

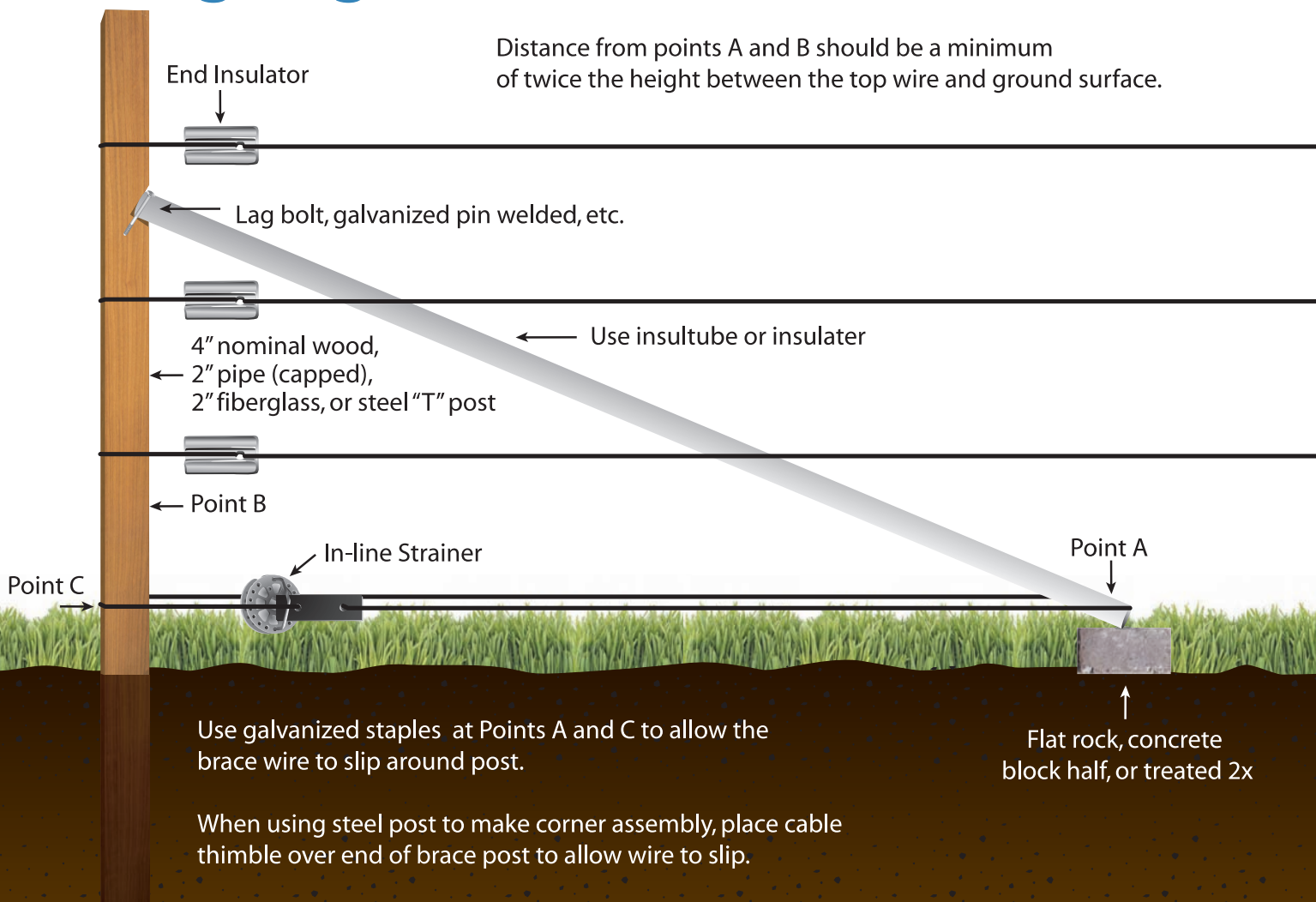

5. **Self-insulating plastic and fiberglass treadin posts** are available for “quickie” temporary fences. Some have a very small treadplate and/or a large spike that makes them difficult to install during dry weather.
6. **Several different installation methods for corner posts, gate posts and pull posts are illustrated in drawings 8a, 8b and 8c.** With one-wire and two-wire fences, the minimum sizes for corner, gate and pull posts are four inches for wood, and two inches for steel pipe and fiberglass.
7. **Here are several things to consider** when it is necessary to use trees as posts:
  - Wire should not be tied directly around a tree because the tree will grow around the wire, which will cause the tree to die prematurely;
  - Insulators nailed directly to trees will pop off as the trees grow;
  - Do not use screw-in insulators because they will cause shorting problems as the trees grow;
  - When using trees as corner posts, end posts or gate posts, screw 3/8 x 8” galvanized eyes into the trees to the depth of the threads, and fasten an end insulator to each screw eye;

**Drawing 8b**

## Knee or Deadman Brace

Knee brace may be used on fences with 1 or 2 wires or where pull distances are less than 660’.

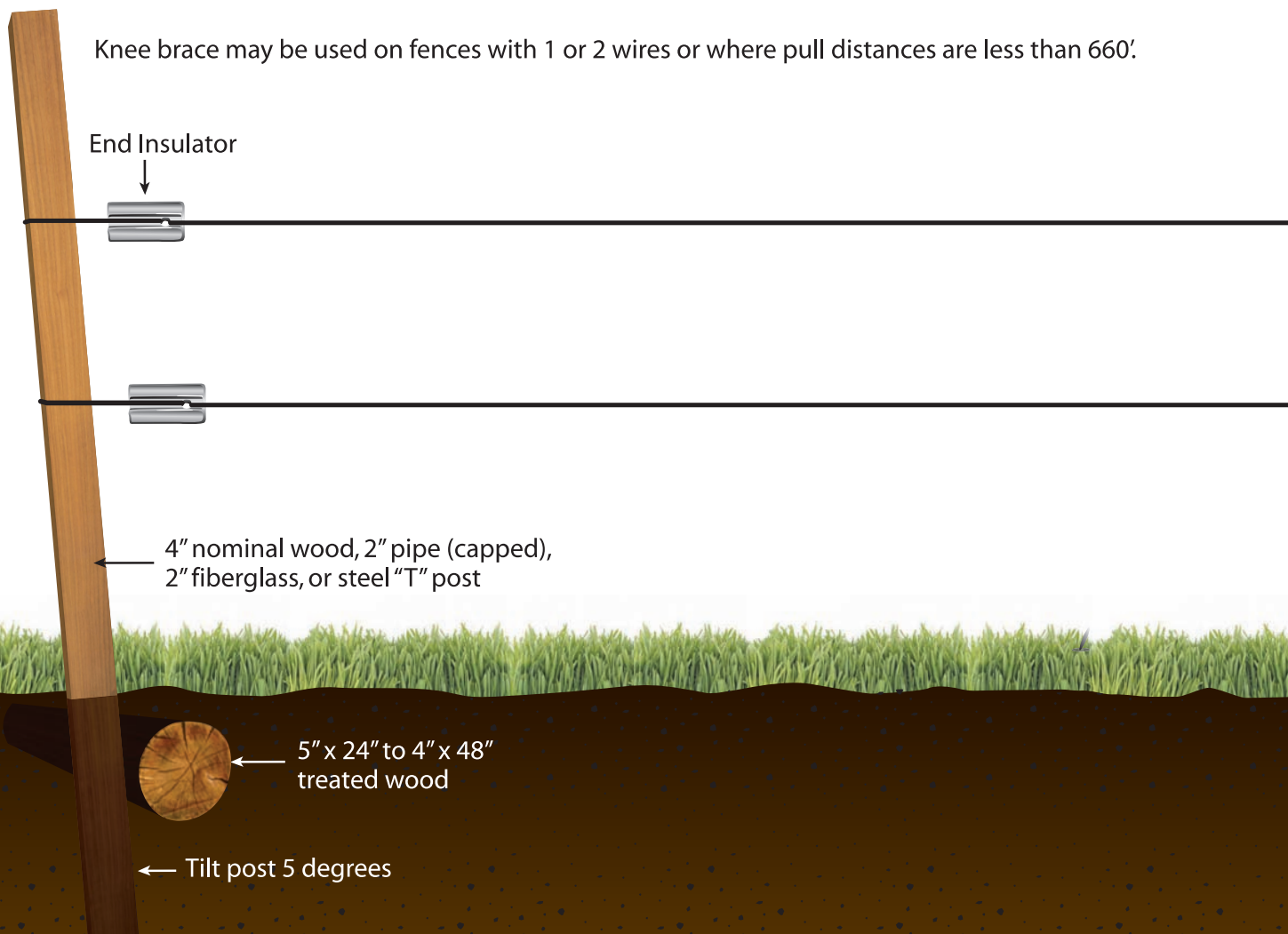

- If a tree is used as a line post, use galvanized screws to attach a short section of treated 2 x 4 or 2 x 6 between the insulator and the tree.

## Stays

Since a stay's only function is to remove sag from a wire, a three-eighths-inch or one-half-inch round, fiberglass post works very well. Stays should be spaced about 50 feet or closer, depending on the lay of the land and the desired wire height.

## Gates

Gates should be wired so that they are dead when unhooked. Use double-insulated underground wire (placed in a pipe for protection) to run power under the gate. Seal ends or turn ends of conduit down to prevent moisture from collecting. Install the gate with an insulator, and power the gate through the gate handle. Use one-sixteenth-inch or one-eighth-inch galvanized cable for the gate because it is much more flexible than high-tensile wire. Use 12.5-gauge crimps for one-sixteenth-inch cable and 9-gauge crimps for one-eighth-inch cable. Gate construction is shown in **Drawing 7** (page 20).

## Drawing 8c "H" Brace

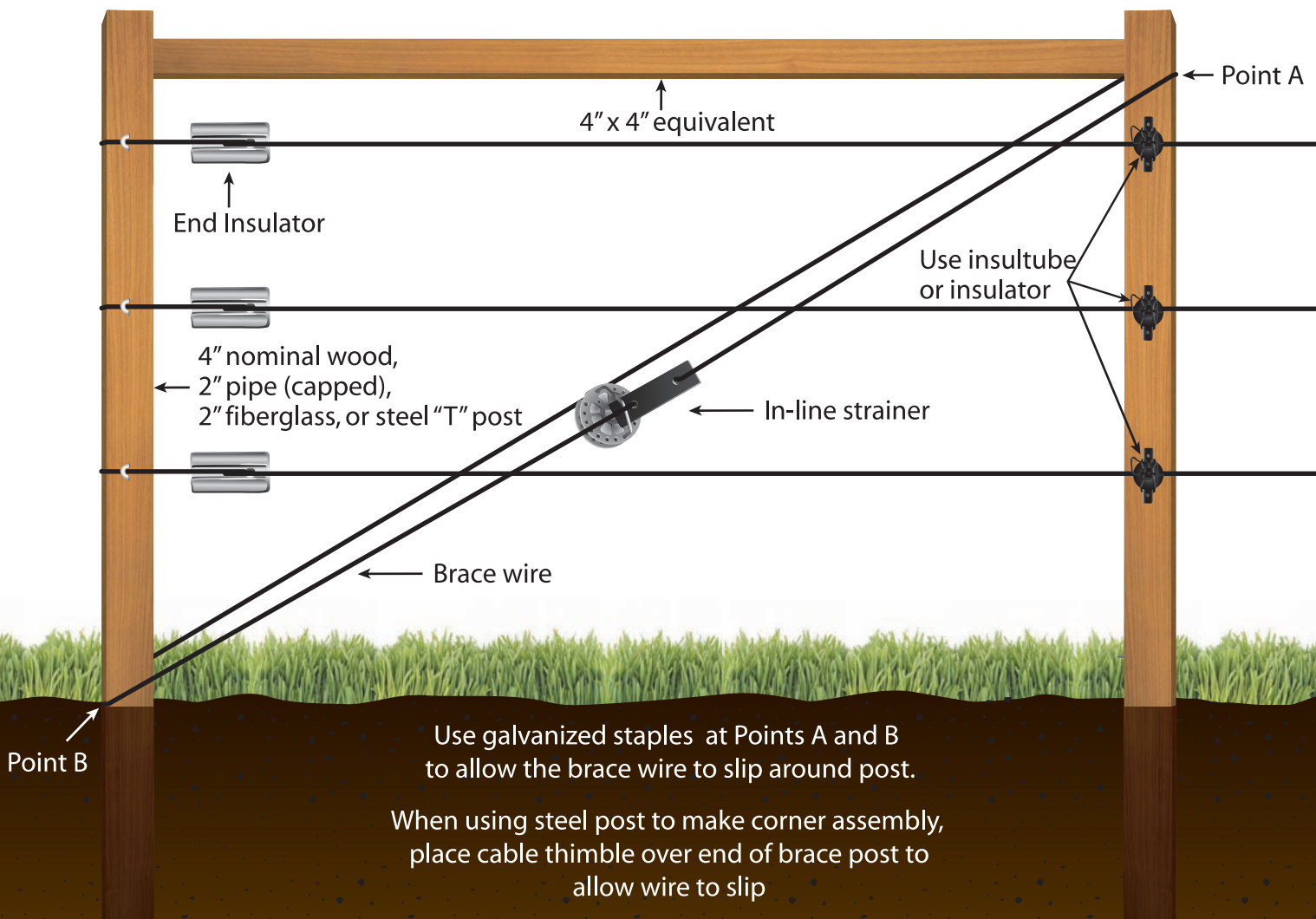

## Gate handle assemblies



## Gate Handles

Finding quality gate handles is a real problem. Some of the higher priced, name-brand handles don't appear to hold up any better than inexpensive



ones. All steel components in the handles should be stainless steel or have a Class III galvanization rating. Some gate handles have compression springs in them. They sell for about the same price as stretch springs, but seem to be more durable.

## Lightning Chokes

These may be purchased or homemade. A coil of insulated wire is compact, inexpensive, and very satisfactory. Choke construction is illustrated in **Drawing 2** (page 11).

## Standoffs (Offsets)

Standoffs are very useful components which attach to permanent barbed or woven wire fences and allow "hot" wires to be installed along the permanent fences. Installing electric wires around

property lines or field borders increases the life of the older, permanent fences because the electric wires keep cattle from pushing against the permanent fences. The electric wires also provide access to electricity for temporary or semi-temporary fences that can divide pastures into smaller units.

Only use galvanized steel wire with quality pin-lock insulators, and place the standoffs beside existing steel T posts in the permanent fences so that the standoffs will not sag. The wires should extend at least 10 inches from the existing fences, with standoffs spaced as close as necessary to maintain the desired wire height.

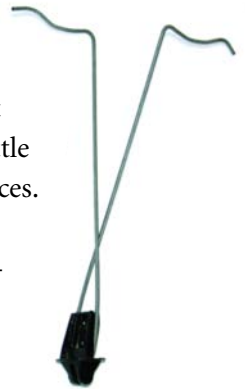

## Water Gaps (Flood Gates)

Electric water gaps work very well. Use a main fence power wire that is high enough to be protected from water and debris with a secondary line feeding off of it. Install metal streamers that hang down to just above the permanent water level.



*Flood gate controller*

Protect this part of the system with a current limiter. **Drawing 9** illustrates how to construct a water gap.

## Miscellaneous

Many other fence components are being produced by fencing companies. The right components for about every situation can usually be found with some searching.

Producers should be innovative; there's nothing wrong with using a product intended for some

other use as long as the quality and longevity is adequate. Examples of being innovative could include the electric cattle guard, floating electrical fence (**Drawing 11**) and the homemade spinner (**Drawing 4**) and crimper (**Drawing 5**).

**Drawing 9**

# Water Gaps (Flood Gates)

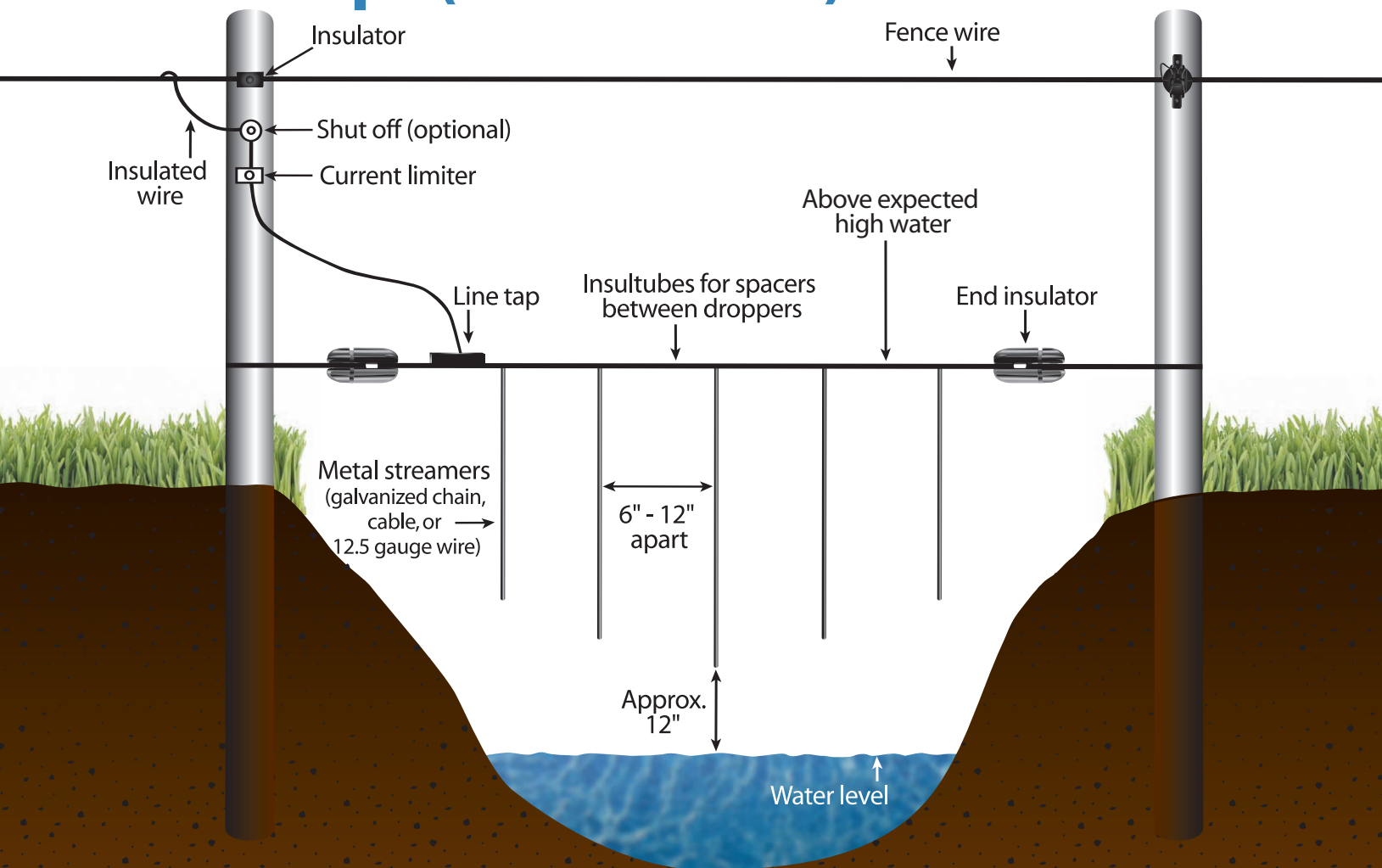

**Drawing 10**

# Drive-Across Electric "Optional Length" Cattle Guard (portable)

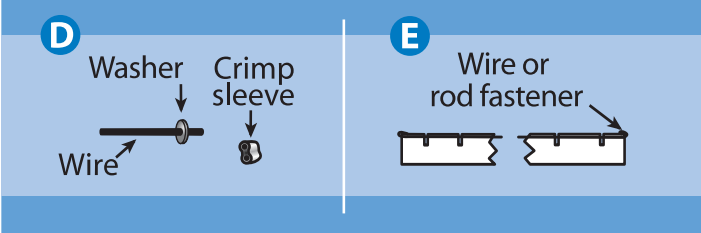
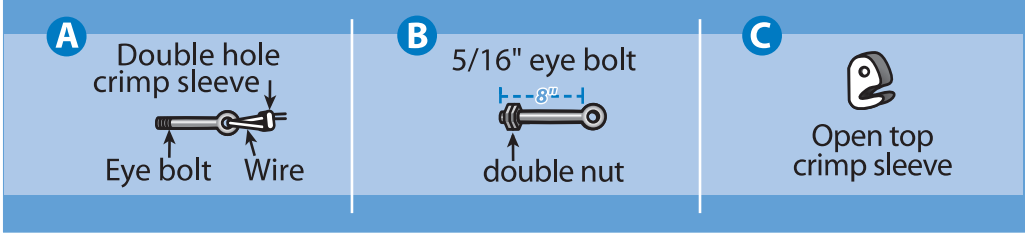
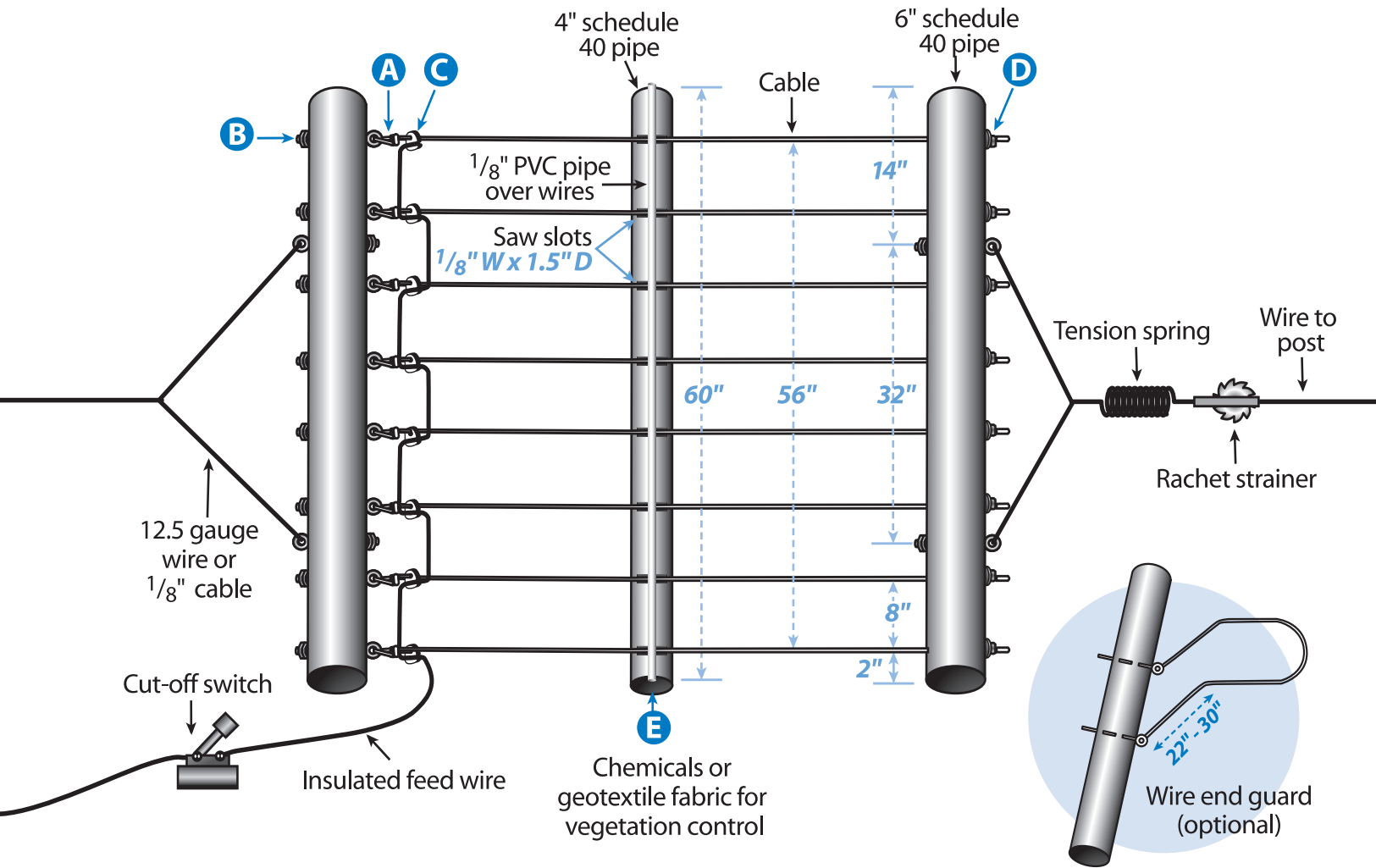



**Drawing 11**

# Floating Electric Fence

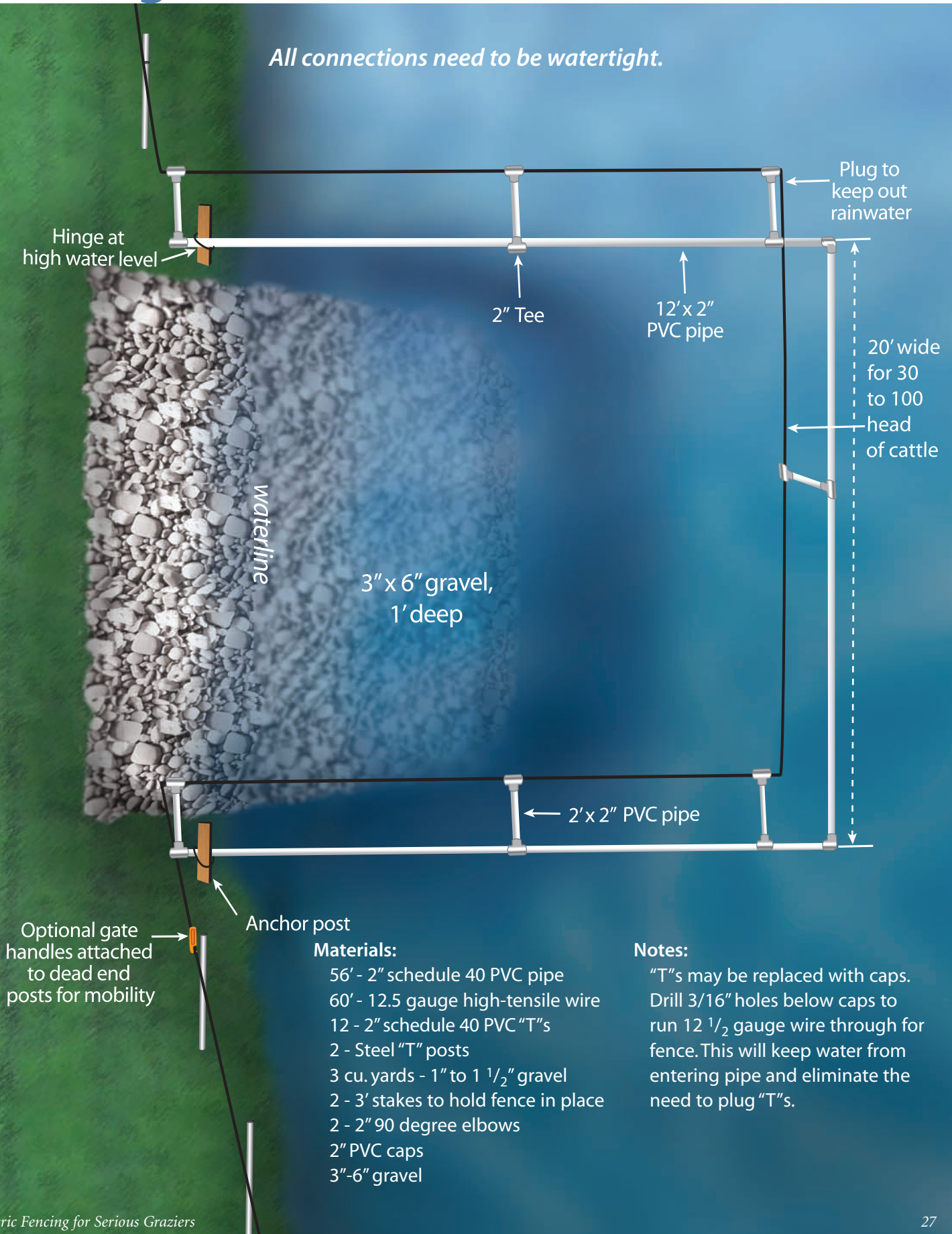

# Electric Fence Safety

Here are some safety considerations to follow when installing electric fencing:

1. **Only connect one energizer to a fence;**
2. **Under unusual fault conditions electric fences can produce sparks.** Therefore, keep fences away from combustible materials. When droughts and other conditions create a high risk of wildfires, operate energizers on low power if they are equipped with that option, or simply turn energizers off.
3. **Grounds for energizers should be at least 65 feet from utility grounding fields;**
4. **Avoid running fences parallel to power lines, and try to install fences so that they cross power lines at right angles.** If you can't avoid parallel electric fences and power lines, offset the fences at least 30 feet from the power lines, and make sure the top fence wires are no more than six feet high.
5. **Do not attach fence wires to utility poles.**
6. **Landowners are responsible for preventing audible interference with telephone lines.** Therefore, try to avoid installing electric fences under telephone wires, and minimize the distance that electric fence wires run parallel to underground telephone cables.
7. **Keep electric fences as far away from radio antennas as possible.**
8. **Don't touch fences with your head or mouth.** People with pacemakers or other heart problems also should consult their doctors before working with or near electric fences. No humans or animals have died from electric, grazing-system fences without becoming entangled in them. However, some precautions are necessary.
9. **Never use barbed wire for electric fence wire because people or animals could more easily become entangled in it.**
10. **Post warning signs at least every 300 feet where the public has access to electric fences, such as along roads.**



## tip:

*All types of wire may break and recoil when stretched. Always use hand and eye protection when handling high-tensile wire.*

***Keep young children away from electric fences.***



# Floodplain Fences

Assuming that fences along streams will eventually wash out or collect debris and become useless, most landowners simply don't build fences in floodplains. However, since there are several programs that provide cost-share funds to install fencing systems that exclude livestock from streams, it is necessary to address methods for constructing floodplain fences.

Modern, one-wire electric fences designed to break at selected locations, if necessary, seem to be working satisfactorily (**Drawing 12**).

With floodplain fencing systems, select sites where very sturdy, wooden, pull posts can be set deep. At least half the length of each post should be underground. Select higher points along streams, avoiding obvious areas where streams flow during high water. If possible, these posts should be 300-400 feet apart. Do not use braces, other than knee braces, since they tend to collect debris.

Between these pull posts, use lighter posts, such as metal or fiberglass "T" posts, round fiberglass posts, etc.

Use only 12.5-gauge, high-tensile wire to construct each section between the pull posts. Place the wire 28-30 inches above the ground for average-sized animals.

Begin placing wire by running it around a heavy-duty, wrap-around insulator at the upstream pull post. Since maximum strength is needed at this point, use double-crimp sleeves. Leave a short, loose "jumper" section of wire that will be needed later to connect the power.

You will end this section of fence with a weaker connection at the closest downstream pull post. While leaving some sag in the high-tensile wire, pull an end insulator to the downstream pull post with 14-gauge soft wire. That's where the fence should break if a floating tree or other debris hits this section of fence during

## tip:

*As with any electric fence, maintenance is important. Therefore, check for limbs, debris and any broken sections of fence after each flood. If possible, set the fence far enough from the bank, trees, etc., so you can pass a bush hog on the stream side of the fence. Mow this strip seasonally, at times friendly to wildlife, to keep weeds and brush out of the hot wire.*

high water flow. If the fence breaks at the downstream end rather than somewhere in the middle, it should be simple to salvage the wire and line posts.

To complete the fence, use split-sleeves and insultube to connect the wire to the loose jumpers left at the upstream end of each section. Split sleeves ensure good electrical connections and are physically weak, so they turn loose when a section of fence breaks.

To protect the system from lightning strikes, use an arrester. The moisture and types of soils in

floodplains make them good places to install lightning arrestors. And, if you expect that a fence will be subjected often to floodwaters, consider using a current limiter.

As with any electric fence, maintenance is important. Therefore, check for limbs, debris and any broken sections of fence after each flood. If possible, set the fence far enough from the bank, trees, etc., so you can pass a bush hog on the stream side of the fence. Mow this strip seasonally, at times friendly to wildlife, to keep weeds and brush out of the hot wire.

## Drawing 12 Floodplain Pull Posts

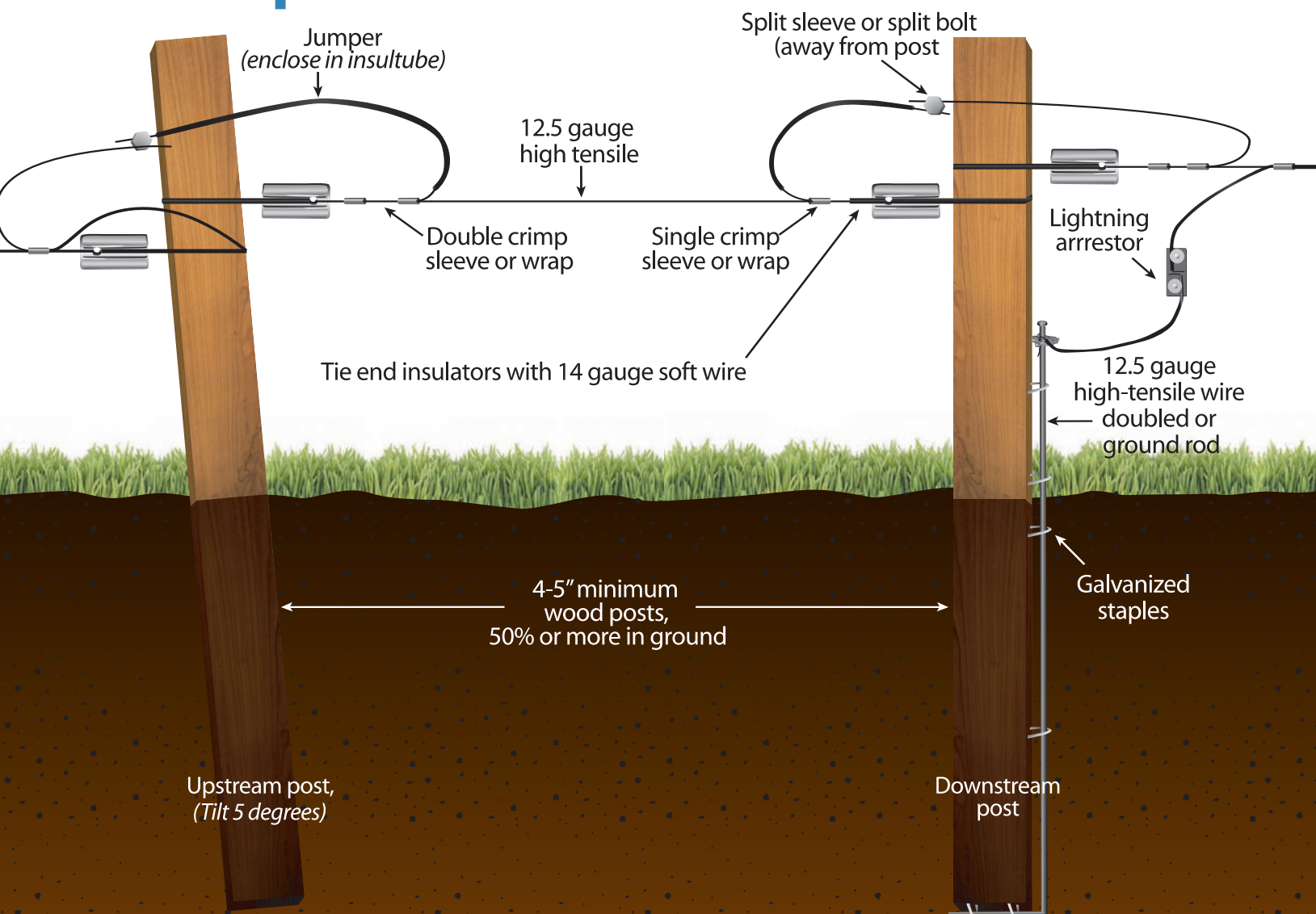

# Electrical Terms

**Resistor:** An electrical component which, due to its material or shape, offers resistance or restriction to the flow of electricity. The degree of restriction is measured in electrical units called ohms. The amount of resistance that will limit the flow to 1 amp when a pressure of 1 volt is applied equals 1 ohm.

Volts/amps = ohms.

**Conductor:** A substance that allows electrons to flow freely. The less resistance a conductor offers, the better the conductor. The unit of conductance is called Mho (ohm spelled backwards). This unit is the reciprocal of the ohm. Amps/volts = Mhos.

**Insulator:** A substance that will not allow any electron flow, and is used to stop electricity from leaking. Most insulating materials have a critical pressure for given thickness. If the critical pressure is exceeded, the insulating material suddenly punctures.

**Leak:** A low-conductance (high-resistance) path from the fence line back to the energizer earth terminal. Leaks are caused by cracked insulators, foliage entangled in the live wire, a length of live wire on the ground, or animals touching the live wire.

**Shorts:** High-conductance (low-resistance) paths between the live wire and either dead wires or earth-return wires. These are commonly known as wire-to-wire shorts. This condition constitutes the largest threat to the reliability and effectiveness of an electric fence line.

**Volts:** Units of electrical pressure (similar to how pounds per square inch are units of physical pressure). One volt is the force necessary to cause a current of 1 amp to flow through a resistance of 1 ohm.

Ohms x amps = volts.

**Amps:** Units of electrical rate of flow (similar to how gallons per hour are units of rate of physical flow). One amp is a flow rate of  $6.28 \times 10^{18}$  electrons per second.

One amp is the rate of electron flow that results when a pressure of 1 volt is applied across a resistance of 1 ohm.

Volts/ohms = amps.

**mAmps:** Units of electrical flow equal to 1/1000 of an amp (a “milli” amp).

**Ohms:** Units of electrical resistance or restriction to the flow of electrons (similar to how a long, thin pipe causes physical resistance or friction to the flow of water through it). One ohm is the amount of resistance that will limit the flow rate to 1 amp when a pressure of 1 volt is applied.

Volts/amps = ohms.

**Coulombs:** Units of electrical quantity (similar to how one gallon is a specific quantity). One coulomb is  $6.28 \times 10^{18}$  electrons, a flow rate of 1 amp for 1 second.

Amps x seconds = coulombs.

**Watts:** Units of electrical rate of doing work (similar to how horsepower is a physical rate of doing work). One horsepower can lift 1 pound vertically at the rate of 550 feet per second, or heat 1 pound of water at the rate of 0.7 degrees Fahrenheit (0.39 degrees C) per second.

46 watts equals 1 horsepower. Therefore, 746 watts can lift 1 pound at the rate of 550 feet per second, or heat 1 pound of water at the rate of 0.7 degrees Fahrenheit per second. A flow rate of 1 amp at a pressure of 1 volt produces 1 watt.

Amps x volts = watts.

**Joules:** Units of electrical energy [similar to how 550 foot pounds (which is equal to 1 horsepower for one second) is a specific amount of physical energy]. 746 joules equals 550 foot pounds. One joule is the amount of energy required to do approximately 0.74 foot pounds of work. One joule is the energy required to produce 1 watt for 1 second.  
Watts x seconds = joules.

**Energy:** The capacity or ability to complete a particular amount of work (see joules). It is largely the quantity of joules released by an energizer during each pulse that determines the energizer's effective power.

3,600,000 joules = 1 kilowatt-hour.

**Capacitor:** An electrical component capable of storing and releasing electrical energy and approximating a reservoir, the volume of which is stated in electrical units called farads (micro farads). If 1 amp flows into a capacitor for one second and this causes a rise in pressure of 1 volt, then the volume of the capacitor equals 1 farad.

Amps x seconds/volts rise = farads.

## Quick Reference

**Ohms** = Volts/amps

**Mhos** = Amps/volts

**Volts** = Ohms x amps

**Amps** = Volts/ohms

**mAmps** = 1/1000 of an amp

**Coulombs** = Amps x seconds

**1 horsepower** = 46 watts

**Watts** = Amps x volts

**Joules** = Watts x seconds

**1 kilowatt-hour** = 3,600,000 joules

**Farads** = Amps x seconds/volts rise

**746 joules** = 550 foot pounds

**1 amp** = flow rate of  $6.28 \times 10$  to the 18th power electrons per 1 second.

**1 coulomb** =  $6.28 \times 10$  to the 18th power electrons, a flow rate of 1 amp for 1 second

- One horsepower can lift 1 pound vertically at the rate of 550 feet per second
- One horsepower can heat 1 pound of water at the rate of 0.7 degrees Fahrenheit (0.39° C) per second.
- 746 watts can lift 1 pound at the rate of 550 feet per second
- 746 watts can heat 1 pound of water at the rate of 0.7 ° F per second.

# Troubleshooting

## Problem 1

Energizer is not on or there is no voltmeter reading across the energizer output terminals with the energizer disconnected from the fence.

- 1A. Probable Cause:** Mainline power outage or blown fuse on input circuit  
**Solution:** Restore power or replace blown fuse
- 1B. Probable Cause:** Energizer is switched off  
**Solution:** Check energizer “on-off” switch.
- 1C. Probable Cause:** Dry cell batteries are dead; wet cell batteries are discharged  
**Solution:** Recharge or replace batteries
- 1D. Probable Cause:** Battery terminals are corroded  
**Solution:** Clean terminals
- 1E. Probable Cause:** Energizer is faulty  
**Solution:** Have energizer serviced

## Problem 2

Energizer is on, but voltmeter reading is low across the energizer output terminals when disconnected from fence.

- 2A. Probable Cause:** Energizer is switched to “low” setting  
**Solution:** Check energizer output switch
- 2B. Probable Cause:** Weak batteries  
**Solution:** Recharge or replace batteries
- 2C. Probable Cause:** Battery terminals are corroded  
**Solution:** Clean battery terminals

## Problem 3

Energizer is operating, but there is no voltmeter reading on the fence with the energizer connected

- 3A. Probable Cause:** Ground-return wire is disconnected or broken  
**Solution:** Connect or repair ground-return wire
- 3B. Probable Cause:** Feed-wire terminals are corroded, disconnected or broken  
**Solution:** Connect or repair feed wire terminals
- 3C. Probable Cause:** Broken, corroded or disconnected live wire or ground-return on fence  
**Solution:** Connect or repair live wire or ground-return on fence
- 3D. Probable Cause:** Soil is dried out  
**Solution:** Install ground-return wire

## Problem 4

Low voltmeter readings at several locations on fence

- 4A. Probable Cause:** Energizer is on low setting or is inadequate for length of fence  
**Solution:** Switch energizer to high setting; install more powerful unit
- 4B. Probable Cause:** Weak batteries  
**Solution:** Recharge or replace batteries
- 4C. Probable Cause:** Terminals corroded  
**Solution:** Clean terminals
- 4D. Probable Cause:** Ground system is inadequate or deteriorated  
**Solution:** Repair or replace ground system



*Improper installation of an electric fencing system can cause a number of problems.*

- 4E. Probable Cause:** Soil is dried out  
**Solution:** Install ground-return wire

### Problem 5

No voltmeter readings at several locations on fence

- 5A. Probable Cause:** Broken or disconnected fence wire, jumper wire or ground wire  
**Solution:** Connect or repair wire; remove cause of short; replace jumper connection

- 5B. Probable Cause:** Broken or faulty insulators  
**Solution:** Replace faulty insulators

- 5C. Probable Cause:** Ground connection rod deteriorated  
**Solution:** Replace ground connection rod

### Problem 6

Voltmeter reading on one wire is higher than on another wire, or there is no reading from one live wire to ground-return or soil

- 5A. Probable Cause:** Broken or disconnected fence wire, jumper wire or ground wire  
**Solution:** Connect or repair wire; remove cause of short; replace jumper connection

- 5A. Probable Cause:** Broken or faulty insulators  
**Solution:** Replace faulty insulators

- 5A. Probable Cause:** Ground connection rod deteriorated  
**Solution:** Replace ground connection rod

### Problem 7

Radio, TV or telephone interference

- 5A. Probable Cause:** Ground system inadequate  
**Solution:** Increase grounding capacity

- 5A. Probable Cause:** Antenna too close to fence  
**Solution:** Relocate antenna or telephone wires

- 5A. Probable Cause:** Fence is parallel with antenna wires or telephone lines  
**Solution:** De-electrify or relocate segment of fence that is parallel to or too close to antenna or wires





***This publication was produced and printed by:***

USDA Natural Resources Conservation Service  
601 Business Loop 70 West, Suite 250  
Columbia, MO 65203

<http://www.mo.nrcs.usda.gov>

***Thanks to:***

Ian Kurtz, NRCS grassland specialist, Ozark, Mo., and Paul Frey, NRCS district conservationist (retired), Buffalo, Mo., who wrote and produced the original version of Electric Fencing for Serious Graziers. Special thanks to Ian Kurtz for his efforts in producing this updated version;

The NRCS grassland committee serving southwestern Missouri, and Mark Kennedy, NRCS state grassland specialist, for providing technical assistance;

The Missouri NRCS Public Information and Marketing Staff for assistance with editing, photography, artwork, layout and design.

**September 2005**



The U.S. Department of Agriculture (USDA) prohibits discrimination in all its programs and activities on the basis of race, color, national origin, age, disability, and where applicable, sex, marital status, familial status, parental status, religion, sexual orientation, genetic information, political beliefs, reprisal, or because all or a part of an individual's income is derived from any public assistance program. (Not all prohibited bases apply to all programs.) Persons with disabilities who require alternative means for communication of program information (Braille, large print, audiotape, etc.) should contact USDA's TARGET Center at (202) 720-2600 (voice and TDD). To file a complaint of discrimination write to USDA, Director, Office of Civil Rights, 1400 Independence Avenue, S.W., Washington, D.C. 20250-9410 or call (800) 795-3272 (voice) or (202) 720-6382 (TDD). USDA is an equal opportunity provider and employer.



*Helping People Help the Land  
in Missouri*

